

# TRIM APPLICATIONS

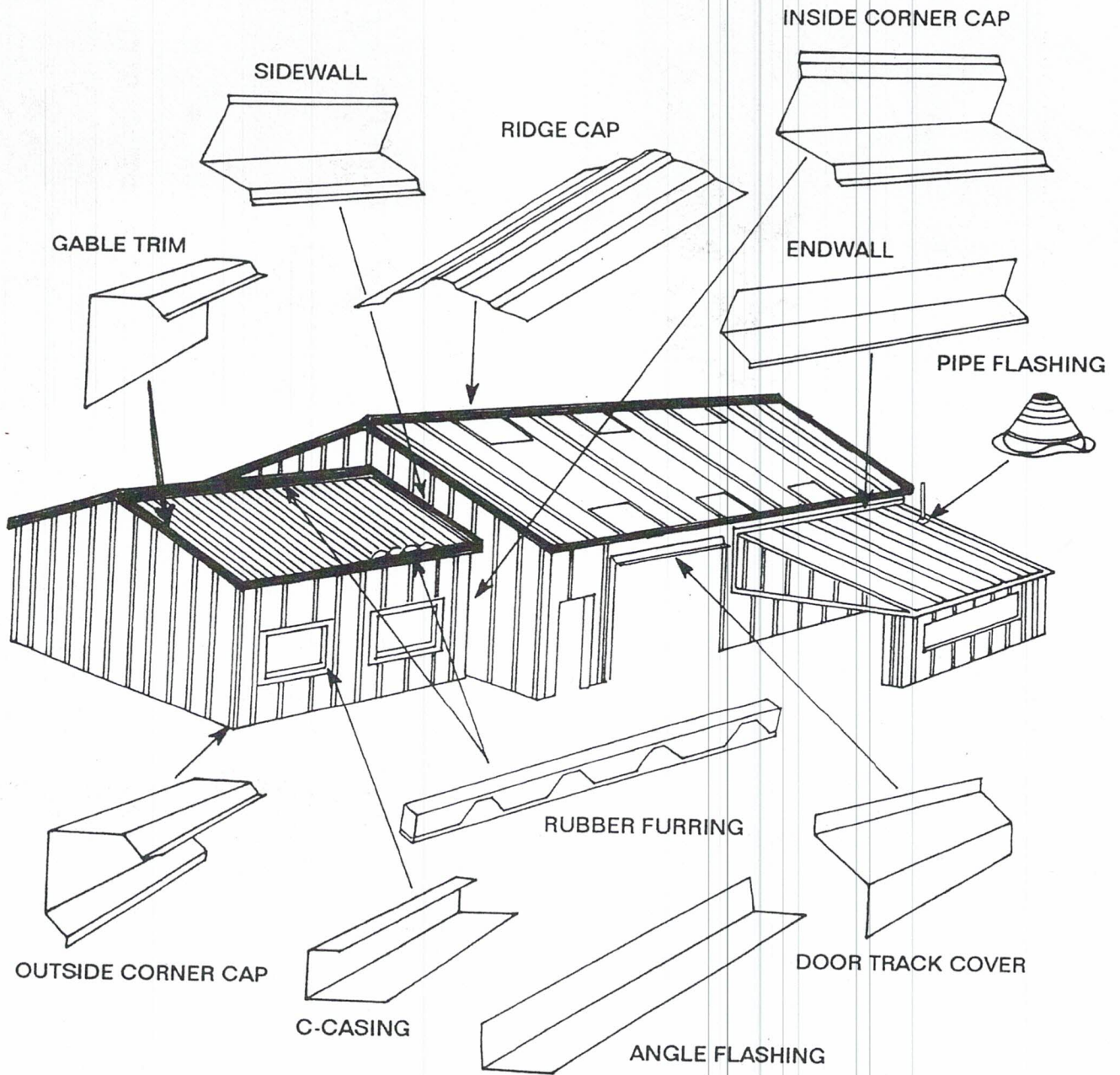

**CORRECT**



Sealing material slightly visible at edge of metal washer.  
Assembly is weathertight.

**TOO LOOSE**



Sealing material not visible.  
Not enough compression to seal properly.

**TOO TIGHT**



Metal washer deformed.  
Sealing material extruded beyond edge of washer.



**MANUFACTURERS OF  
METAL ROOFING, SIDING AND ACCESSORIES**

1305 S.W. Lake Road / Redmond, Oregon 97756  
(541) 548-7044 FAX (541) 548-7440

# 3' TUFF-RIB PANEL

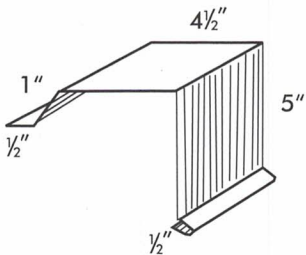
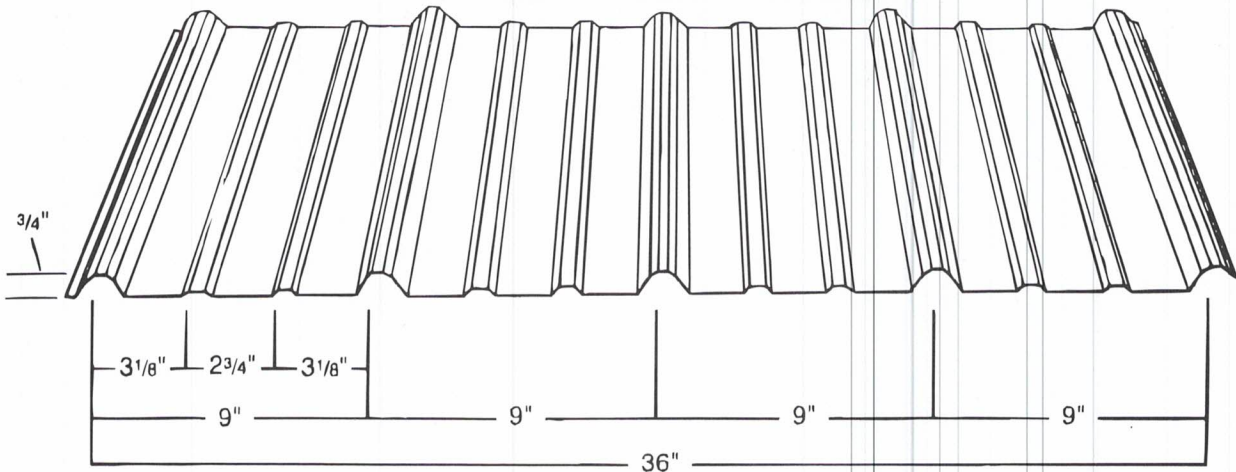

GABLE END TRIM

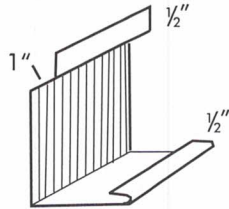

DOOR POST COVER

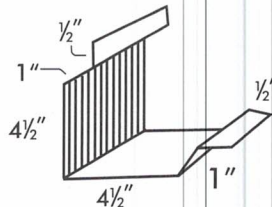

OUTSIDE CORNER CAP

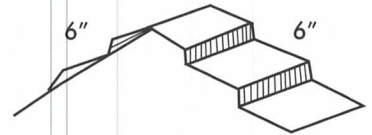

RIDGE CAP

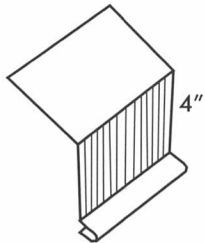

EAVE TRIM

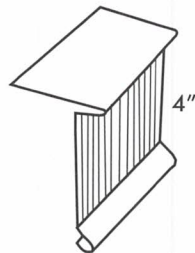

RETURN EAVE

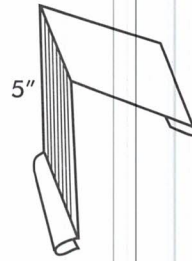

REVERSE EAVE

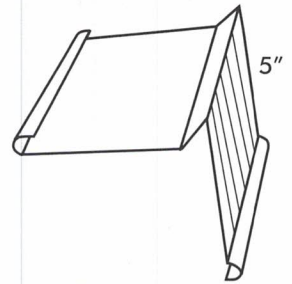

SWEPT WING  
GABLE END

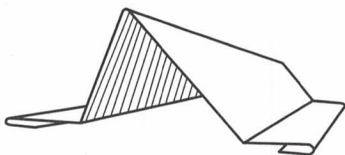

SNOW STOP

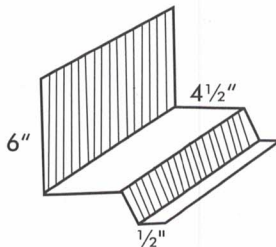

SIDEWALL

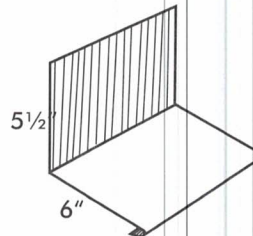

ENDWALL

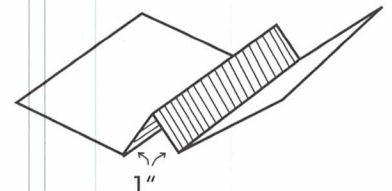

W-VALLEY

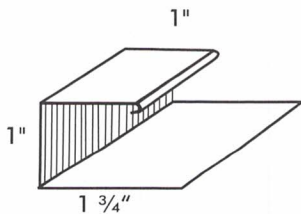

J - CHANNEL

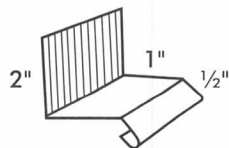

BASE TRIM

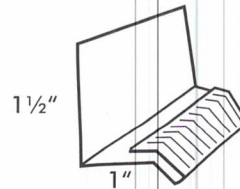

HEADER FACE

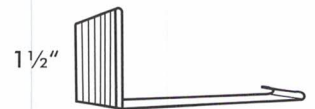

JAMB COVER

**(TRIM IS NOT LIMITED TO THESE DRAWINGS AND DIMENSIONS)**



MANUFACTURERS OF  
METAL ROOFING, SIDING AND ACCESSORIES

1305 S.W. Lake Road / Redmond, Oregon 97756

TEL: 503-754-7111 FAX: 503-754-7111

# T-LOCK PANEL

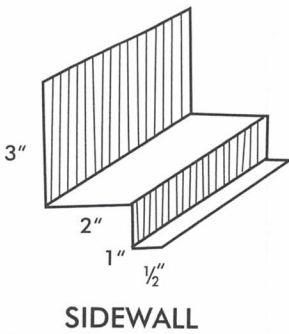
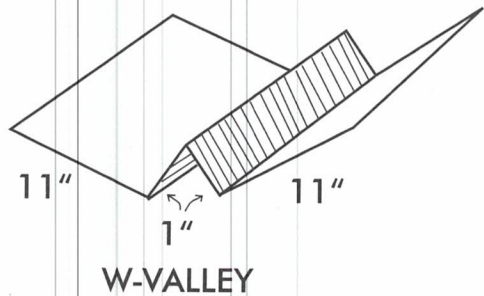
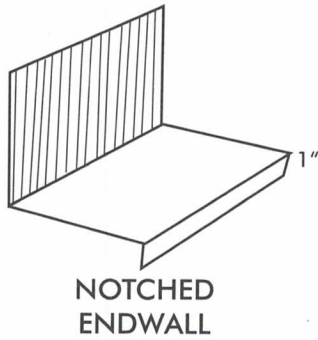
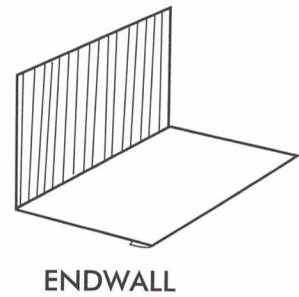
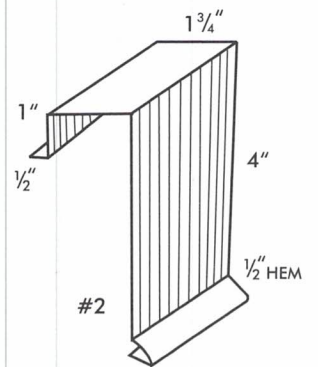
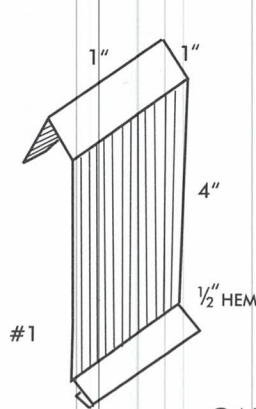
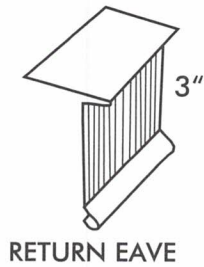
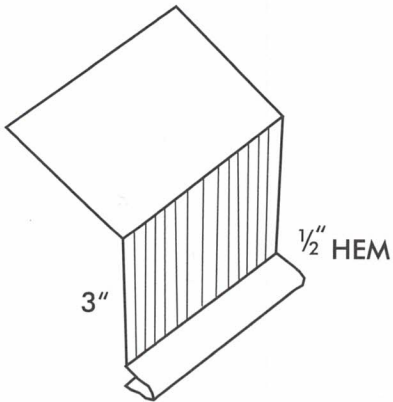
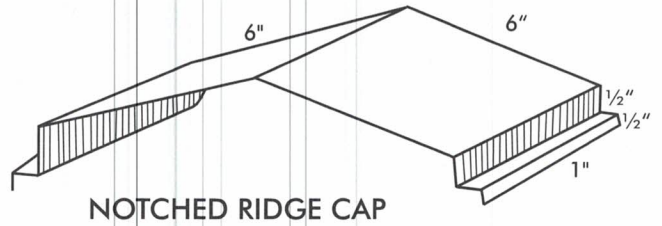
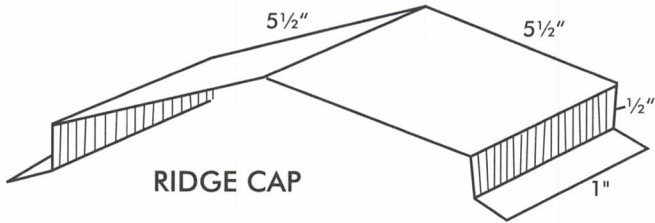
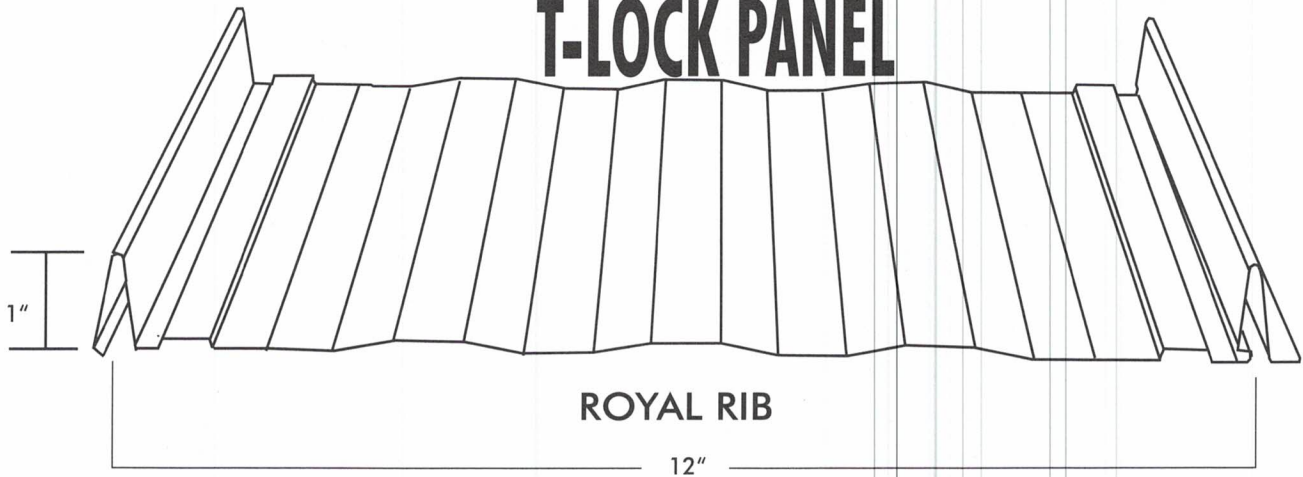

MANUFACTURERS OF METAL ROOFING, SIDING AND ACCESSORIES  
1305 S.W. Lake Road / Redmond, Oregon 97756  
(541) 548-7044 FAX (541) 548-7440

Custom Trim upon Request

